

PARTS

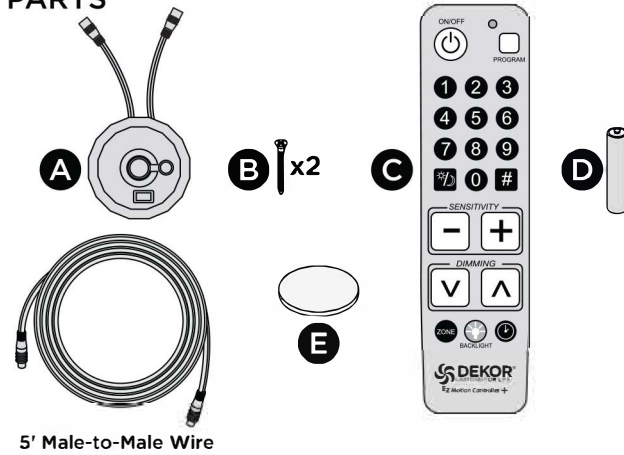

**EZ MOTION CONTROLLER+
SENSOR OVERVIEW**

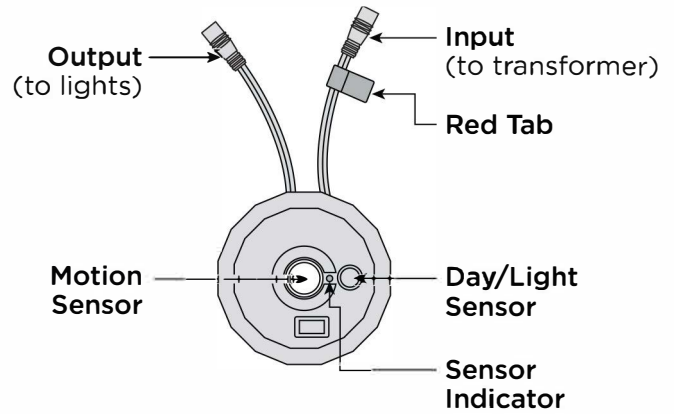

TOOLS NEEDED

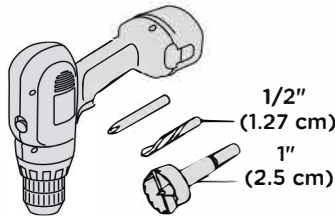

**EZ MOTION CONTROLLER+
SENSOR INSTALLATION LOCATION**

Install the Motion Controller in a location that is exposed to some ambient sunlight. If you plan to use the motion sensor capabilities of this unit, place it in a location that allows the center of the unit to face the location of the motion. For example, the door leading onto the deck, or at the bottom or top of stairs are common locations. However, the most important consideration of Motion Controller location is how you will install it into your lighting circuit. See illustrations on next page for some basic examples.

DEKOR PHOTOCELL MOTION CONTROLLER OVERVIEW

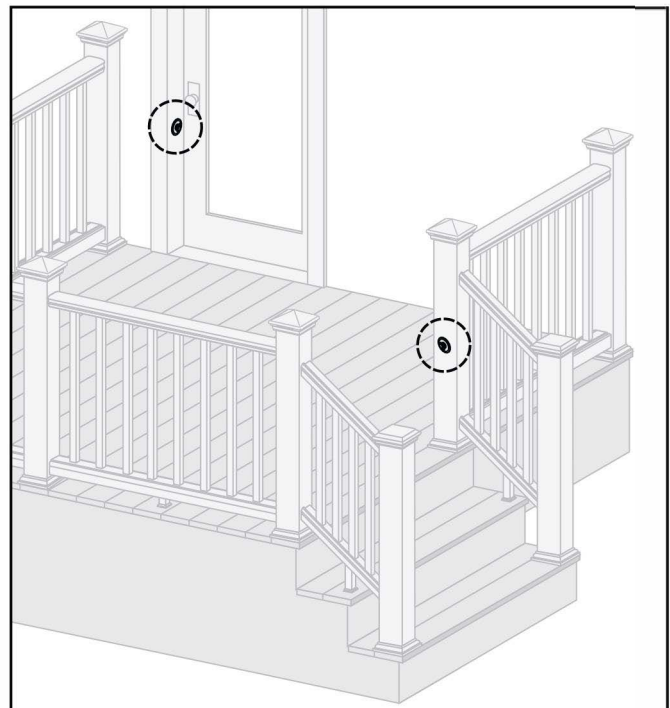
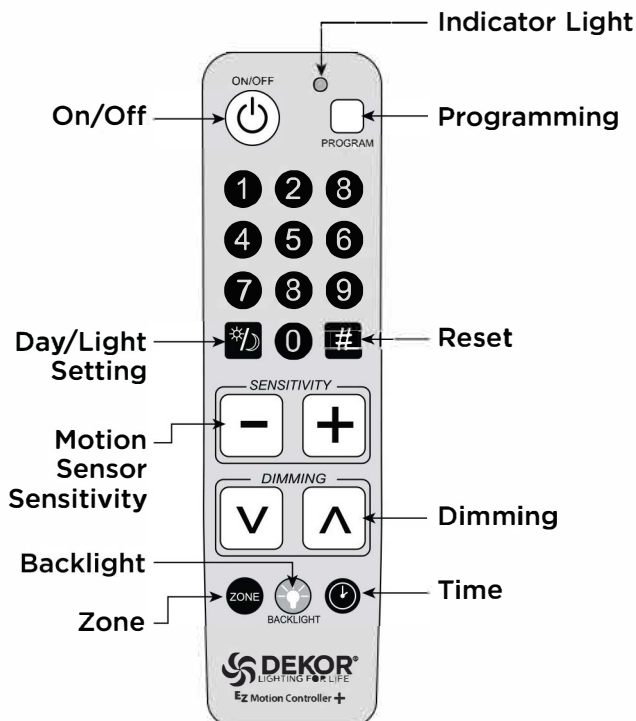

NOTE: Construction methods are always improving. Please ensure you have the most up-to-date installation instructions by visiting: DEKORLighting.com

HOW TO INSTALL EZ MOTION CONTROLLER +

Making A Post Pocket

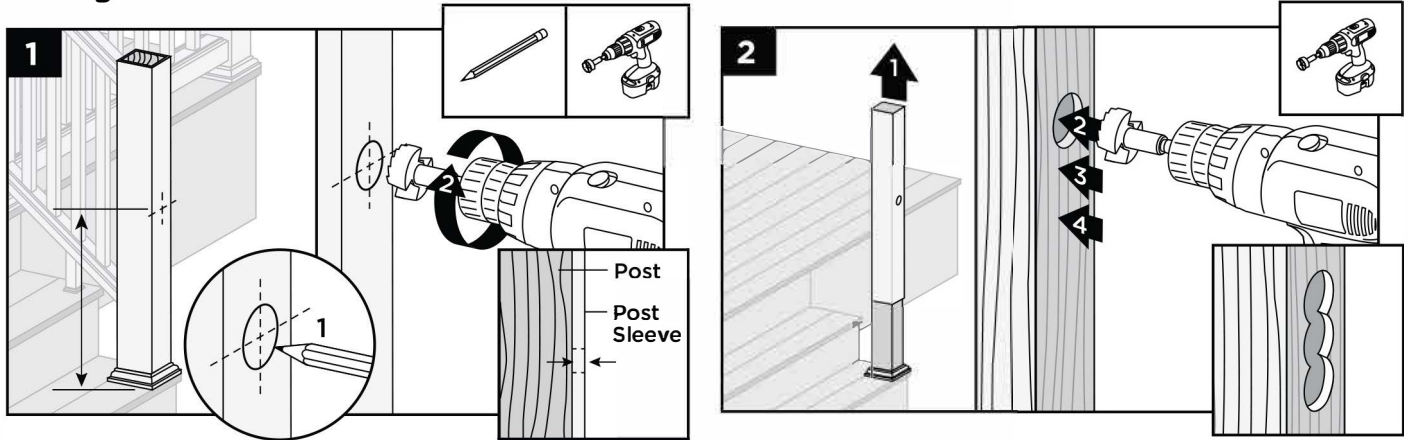

Aluminum Post Install

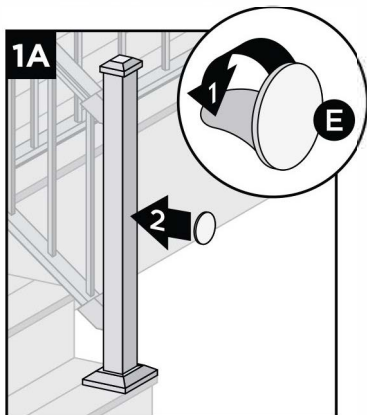

One Sensor Install

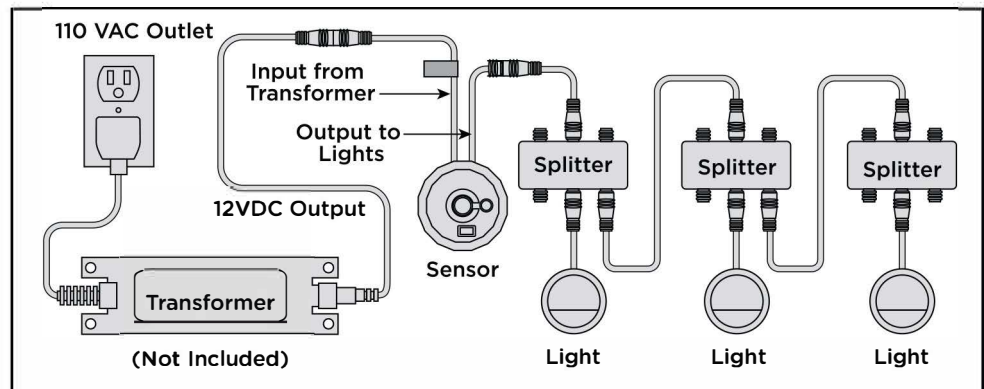

Note: Make sure the sensor is installed after the transformer, but before the first light. Any lights that are installed before the sensor will not be controlled.

Two Sensor Install

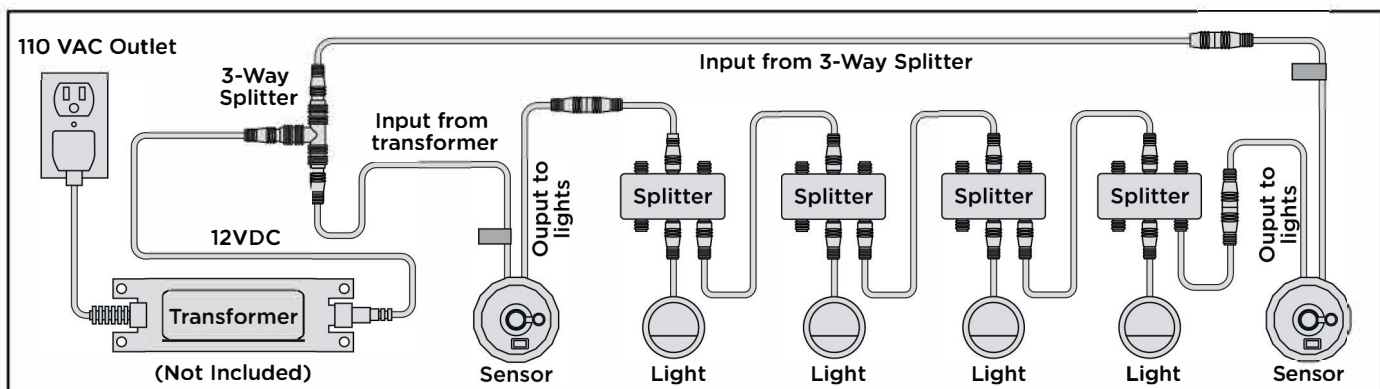

To install two sensors, place a motion sensor at each end of the circuit, making sure you connect the wire with the red tab to the transformer side of each circuit.

HOW TO INSTALL EZ MOTION CONTROLLER+

- CONTINUED

To install multiple circuits, use the 5-Way Transformer Splitter and (1) additional 20' Transformer wire (available on DEKORlighting.com) for each circuit you're setting up. Then simply follow the instructions for the one-sensor installation above.

Multiple Zone Install

To run multiple zones, you simply create multiple one-sensor circuits. For example, we recommend running your recessed lights on one dimmer circuit and your post lamps, post lights and riser lights on another. Once installed, you can program each sensor for the appropriate motion sensitivity and light output for that circuit. Ensure that all sensors are on the same time setting if you want all of the lights to come on/go off at the same time.

ADJUSTMENTS

Motion Sensor

The motion sensor is set to maximum range at the factory. If you want to prevent the motion sensor from controlling the lights, adjust it to the lowest setting.

Step 1

Install and mount controller per previous instructions. Plug in lights.

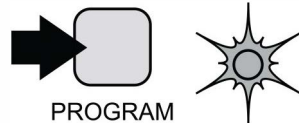

Step 2

Press and hold **Program** button on the remote for 4 seconds. The blue light on the motion controller will light up solid.

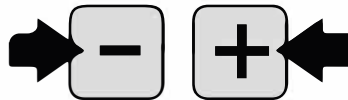

Step 3

Use the +/- buttons to adjust the sensitivity of the motion sensor. There are 9 steps between maximum range and minimum range. The indicator light will blink twice when either limit is reached. The lowest limit will deactivate the motion sensor.

Tip: The motion controller senses heat. Therefore, ambient temperatures can affect sensitivity. The cooler the ambient temperature the greater the detection range. **Max Setting = 25 feet at 72 °F.**

ADJUSTMENTS/CONTINUED

Step 4

Press **Program** button once to save. Press **Program** button again to exit programming mode.

Tip: The motion sensor will not activate the lights if the photocell senses daylight.

Photocell Sensor

Adjustment of the photocell is usually not necessary. (It is factory pre-set to 3.) However, if you place the receiver in an area that gets very little ambient light, you might need to turn the sensitivity up for it to function properly. Alternatively, if you want to use the receiver as a motion controller-activated device only, you may set the photocell sensitivity to 0. In that setting, the only time your lights will illuminate is when the motion sensor is activated.

Step 1

Install and mount controller per instructions above. Plug in lights.

Step 2

Press and hold **Program** button on the remote for 4 seconds. The blue light on the receiver will light up solid.

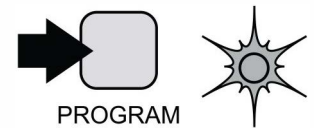

Step 3

Press the **Day/Light** button on the remote. The receiver will blink once. Enter a number on the keypad 0-9.

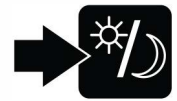

1 = Complete darkness required to activate photocell
 9 = Photocell operates in full sunlight.
 0 = Photocell will no longer control lighting system.

Step 4

Press **Program** button once to save. Press **Program** button again to exit programming mode.

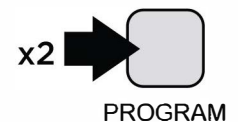
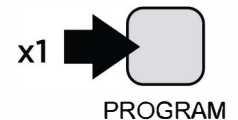

ADJUSTMENTS/CONTINUED

Time Duration

Adjustment of the timer controls how long the lights stay on once activated by the photocell or motion sensor.

Step 1

Install and mount controller per instructions above. Plug in lights.

Step 2

Press and hold **Program** button on the remote for 4 seconds. The blue light on the receiver will light up solid.

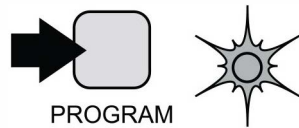

Step 3

Press the **Timer** button, then enter the desired number of minutes desired (1-999).



Step 4

Press **Program** button once to save. Press **Program** button again to exit programming mode.

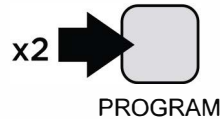
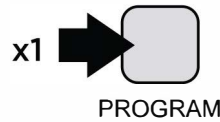

Tip: When installing multiple motion controllers on the same circuit they both must be set to the same time duration.

OTHER BUTTONS/FUNCTIONS/ZONES

Backlight

Press the **Backlight** button to illuminate the remote in low light conditions.



Hashtag (Reset)

Step 1

Press and hold the **hashtag** button for 6+ seconds until the receiver indicator light blinks twice.

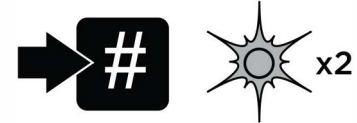

Step 2

Press the **On/Off** button to turn the system off, then press the **On/Off** button again to complete the factory setting reset process.

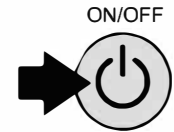

Zone

Assign/select zones for each receiver.

Step 1

To assign or change zone press and hold the **Program** button until receiver indicator lights up.

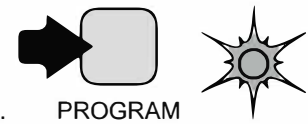

Step 2

Press **Zone** button; enter zone number (1-9).



Step 3

Press **Program** button once to save. Press **Program** again to exit programming.

