

PARTS

A Illuminated Post Caps



B Post Lamps



C Recessed Lights

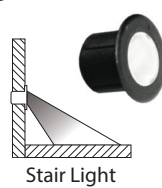

Up Light

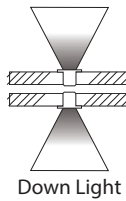

D DEKDOT™ Lights



E Splitter



» 5', 10', 20', 40', and 60' male to male connection/extension wires sold separately.

LIGHTING AND WIRING OVERVIEW

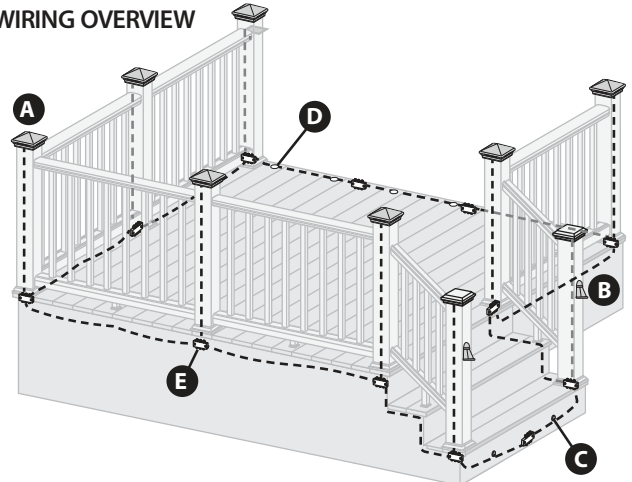

TOOLS NEEDED

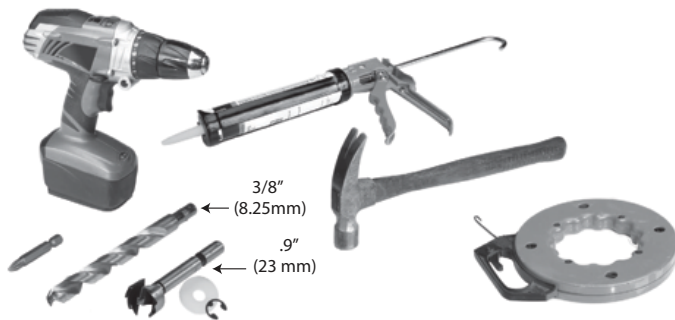

NOTE: All wiring and splitters are mounted to inside of framing, picture is just representation of where to place these in general.

NOTE: Avoid railing brackets and locations for deck rail lights when running wires up posts.

NOTE: It is recommended to install wiring and splitters before decking and railing have been installed. **DO NOT** run wires between joists and deck boards.

HELPFUL TIPS

- » Follow the appropriate building and electrical codes when installing all DEKOR® lighting products.
- » Leave wire slack to make fixture terminations.
- » Recessed lights work best when spaced 4' (1.22m) to 6' (1.83m) on center around perimeter of deck.
- » It is recommended to determine placement of lighting under dark conditions prior to drilling/installation.
- » Post lights should be used at the top or the bottom of the stairs, or used in conjunction with post cap lights.
- » Carefully drill holes perpendicular to surface to avoid producing an enlarged hole. Light fixture will have a loose fit if hole is enlarged. **NOTE:** Silicone caulk will be required to anchor light in place in over-drilled recessed light holes.
- » It is best to use splitters at each post that has lights and, depending on spacing, in between each DEK-DOT™ and recessed light.
- » Unused splitter female connections need to be capped. Either use provided caps or a weather resistant silicone to prevent corrosion or water damage.
- » All splitter female connection ports are powered so any or all can be used.
- » **DO NOT** use more than one transformer on each circuit.
- » Each light has a pig-tail lead attached with an approx. 5.5' (1.8m) length and has a male connector that plugs into splitter.
- » To ensure all components are in working condition it is recommended to have power source attached when installing lights.

CAUTION:

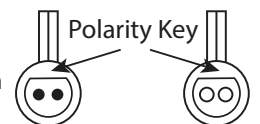

When making a connection between a Plug N Play connector or a splitter; observe the polarity key to make the proper connection. The male and female connectors have a flat side that **MUST MATCH UP. DO NOT** force the connectors together.

How to install DEKOR® Deck Lighting / CONTINUED

General Information

- » ALWAYS check local codes before beginning your project.
- » USE DEKOR® TRANSFORMERS ONLY. Using any other type of transformer voids the warranty.

TRANSFORMER CAPACITY BY TYPE		
Type of Light	5A Transformer EZ Max Transformer	2.5A Transformer EZ Transformer
DEK-DOT™	52	31
Recessed	52	31
Post Cap*	15	9
Post Light	52	31

The list above is for maximum number of each individual types of lights.
 *Post Cap capacity numbers based on a cap lit four sides. If mixing and matching lighting or using Post Caps that have less than 4 side lit up reference the transformer calculator at DEKORLIGHTING.com.

Planning

NOTE: Prior to installing, plan locations of lights, power supply, timer, and dimmer. These need to be accessible for service. It is required to install a GFI to help prevent damage to lights caused by electrical surges.

1. Dimmer remote works in a 30' (9 m) radius of the unit.
2. Install dimmer in a dry location.
3. You must install timer vertically with receptacle facing down. Timer must be at least 1' (.305 m) from ground level when installed as per federal safety code height regulations. To use the dusk/dawn feature the timer must be in view of the sun.

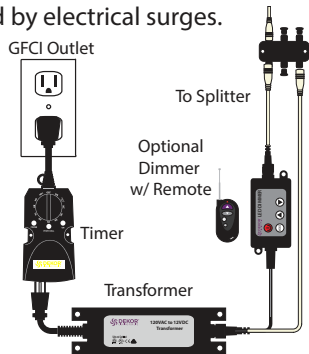

Installing Wiring

NOTE: It is best to install wiring and splitters before railing and decking have been installed.

- » Connect to each required splitter using Male-to-Male connection wire (lengths vary).

1. You must run wiring under decking structure and behind stringers. DO NOT run wires between joists and deck boards. Use cable staples at least 1/4" (0.6 cm) wide to staple to frame. DO NOT crush wire insulation with staple.

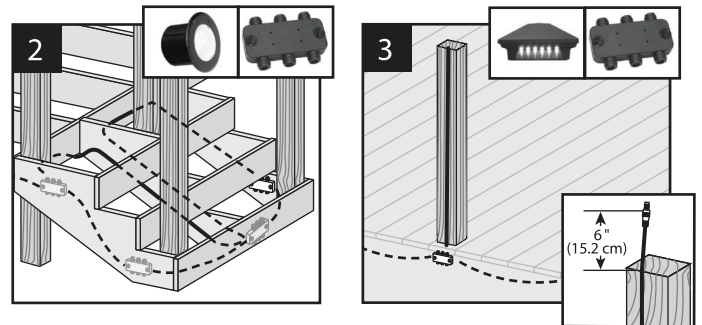
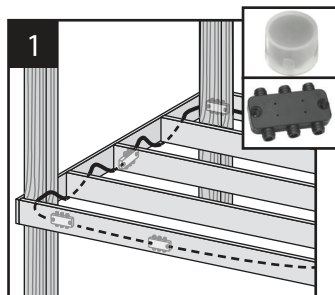

2. Wiring can be run under deck and behind risers. Use cable staples at least 1/4" (0.6 cm) wide to staple wire to frame. DO NOT crush wire insulation with staple.
3. Remove 5' (1.52 m) lead wire that is connected to post cap. Attach wire to post with male connection at top of post (female connection at bottom of post to connect with male-to-male extension to connect into splitter). Avoid running wire on side of post where railing brackets or deck rail lights will be installed. Leave approximately 6" (15.2 cm) of lead at top to make connections. Staple to frame and posts with cable staples at least 1/4" (0.6 cm) wide. DO NOT crush wire insulation with staple.

Making Connections

1. Using hardware provided install splitters to inside of framing. Install at every post base where lighting is present and depending on spacing in between each riser and recessed light.

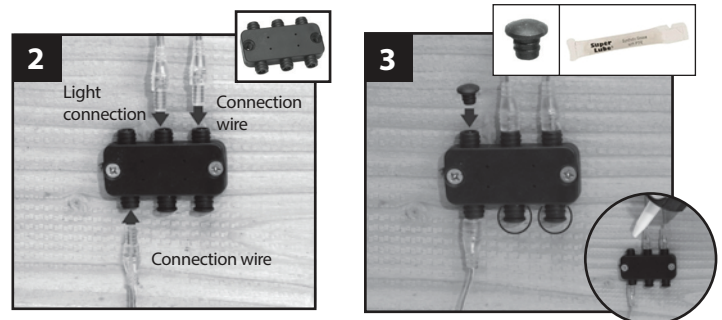
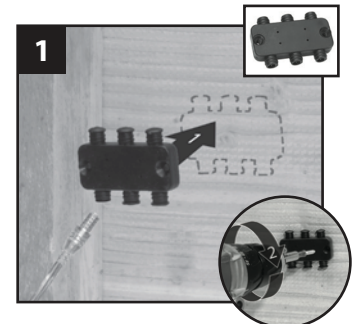

2. Attach male lead from lights to female connections on splitter. Attach male-to-male connection wires in between each splitter. Continue until all wiring from lights are attached to splitters and connector wires are attached in between splitters.
3. Use dielectric grease on all connections. Cap off all unused female connections on wires and splitters using the provided caps.

How to install DEKOR® Deck Lighting / CONTINUED

Installing Post Cap Lights

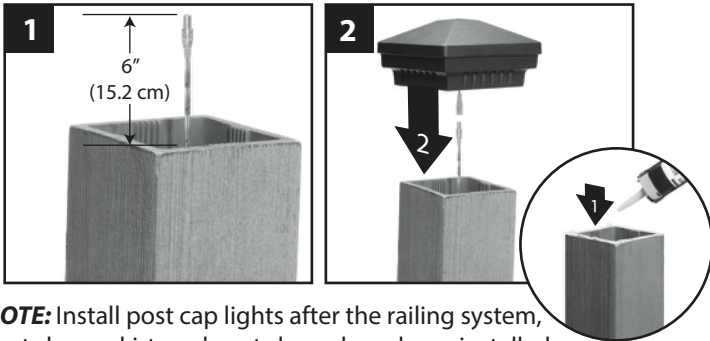

NOTE: Install post cap lights after the railing system, post sleeve skirt, and post sleeve have been installed.

1. Connect male lead from wiring to female connector from cap. Attach male-to-male connection wires in between each splitter. Continue until all wiring from lights are attached to splitters as well as connector wires are attached in between splitters. (See Making Connections section for details.)
2. Attach cap to top of post with silicone caulk after verifying wiring is correct by turning lights on.

Installing Post Lights

NOTE: Instructions shown below are for new deck installation and are shown BEFORE railing system has been installed.

1. Place post sleeve over pressure-treated post and mark desired height, centered on post sleeve for deck rail light location.

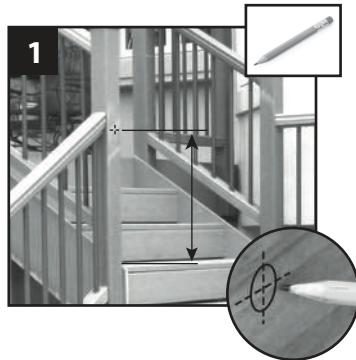

NOTE: If deck boards are not installed yet place an appropriate deck width spacer board to ensure post sleeve is at correct height.

Photocell/Timer Operation Instructions

1. Select the mode of operation:
 - » Dusk to Dawn
 - » 1 - 8 hours
 - » Always "On"
 - » "Off"

Program repeats daily.
When power is flowing to lights, green light above POWER is on.

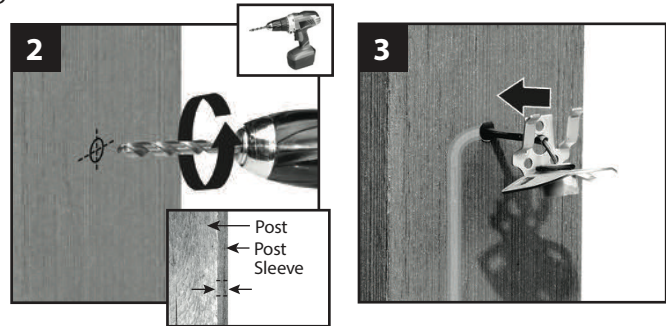
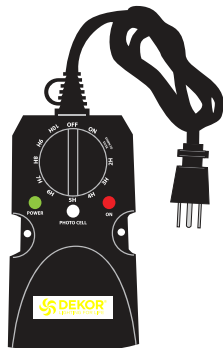

2. Drill a 3/8" (8.25mm) hole through post sleeve. Be sure to stop drill before cutting into post.

3. Remove the post sleeve from the post and fish wire from deck rail light through hole and down to female connector on splitter. Attach male-to-male connection wires in between each splitter. Continue until all wiring from lights are attached to splitters as well as connector wires are attached in between splitters. (See Making Connections section for details.)

IMPORTANT NOTE: Before attaching deck rail light to the post/post sleeve make sure decking has been installed along with skirt over the post sleeve.

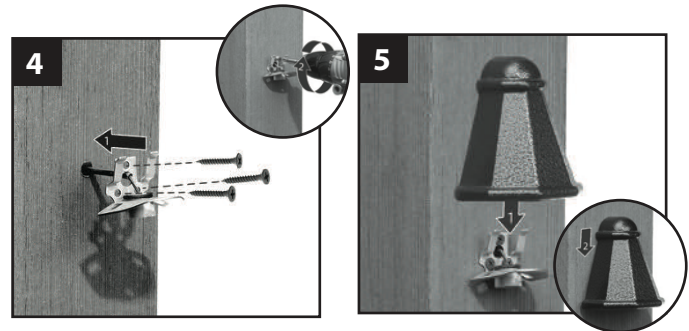

4. Replace post sleeve over pressure-treated post and align holes for screws vertically and attach fixture base to post with provided screws.

5. Line up and slip on Post Light housing.

NOTE: If railing has already been installed, lead wires will need to be fished through the post sleeve to reach the desired location for the deck rail light. In some cases if the provided lead wire does not fit (due to connector size), the wire connectors can be cut off and wire nuts can be used. Test lights with the power on. If lights wired with this method do not function, switch the connector wires.

How to install DEKOR® Deck Lighting / CONTINUED

Installing Stair/Recessed Lights

NOTE: Recessed lights should be installed after stairs and risers have been installed.

1. Mark location for light, typically 4" (10.2cm), above tread. Check local codes for lighting requirements.

NOTE: Avoid areas over stringers when possible because it will be more difficult to drill holes.

2. Drill a .9" (23mm) diameter hole at least 1" (2.5 cm) deep into riser. If riser material is thicker than 1" (2.5 cm), use a 3/8" (8.25mm) drill bit to create a hole for wires that goes all the way through riser.

3. Thread wires through hole.

4. Remember to add some silicone adhesive caulk around the case to insure proper seal and adhesion.

5. Press light housing into hole, then insert light and lens. Make connections behind stairs. Male lead wire from recessed light goes into a female connection on splitter. Also attach male-to-male connection wires in between each splitter. Continue until all wiring from lights are attached to splitters and connector wires are attached in between splitters. (See Making Connections section for details.)

NOTE: Stair LEDs are set at 30° angle to cast light on tread. Make sure Stair Lights are set in case with LEDs pointed toward stair tread. Both Standard and NexGen™ Stair Lights are set to aim lights at an angle.

Standard LED



Stair Light

Up/Down Light

NexGen™ LED



Stair Light

Up/Down Light

Installing Recessed DEK-DOTS™ Deck Lights

NOTE: Install recessed DEK-DOTS™ deck lights after installing decking.

1. Mark location for DEK-DOTS™ on deck boards.

NOTE: Avoid locations over joists when possible because it will be more difficult to drill holes.

2. Use the Forstner bit and drill a .9" (23mm) dia. hole 3/4" (1.9 cm) deep into board. Make sure hole does not go all the way through deckboard or light will fall through. Drill a 3/8" (8.25mm) diameter hole in base of the first hole through deck board to run Plug-N-Play wire.

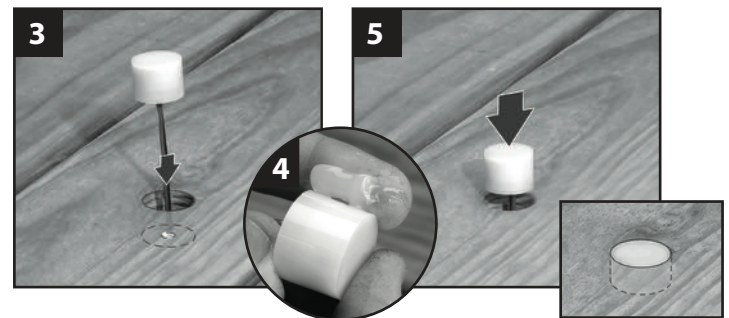

3. Thread wires through hole. DO NOT pull DEK-DOT™ into hole by pulling on wires. This may damage wires or DEK-DOT™.

4. Remember to a small amount of silicone adhesive around the dot to insure proper seal and adhesion.

5. Press DEK-DOT™ into hole until flush with surface. Make connections under deck. Male lead wire from riser light into female connection on splitter. Also attach male-to-male connection wires in between each splitter. Continue until all wiring from lights are attached to splitters and connector wires are attached in between splitters. (See Making Connections section for details.)