

PARTS

A Sapphire, Petite, and Elite Post Light



B Splitter



» 5', 10', 20', 40', and 60' male to male connection/extension wires sold separately.

TOOLS NEEDED

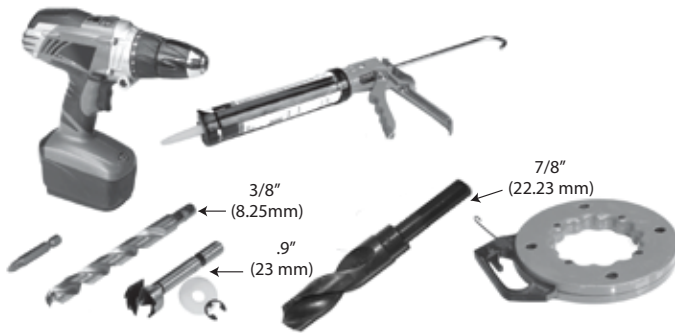

LIGHTING AND WIRING OVERVIEW

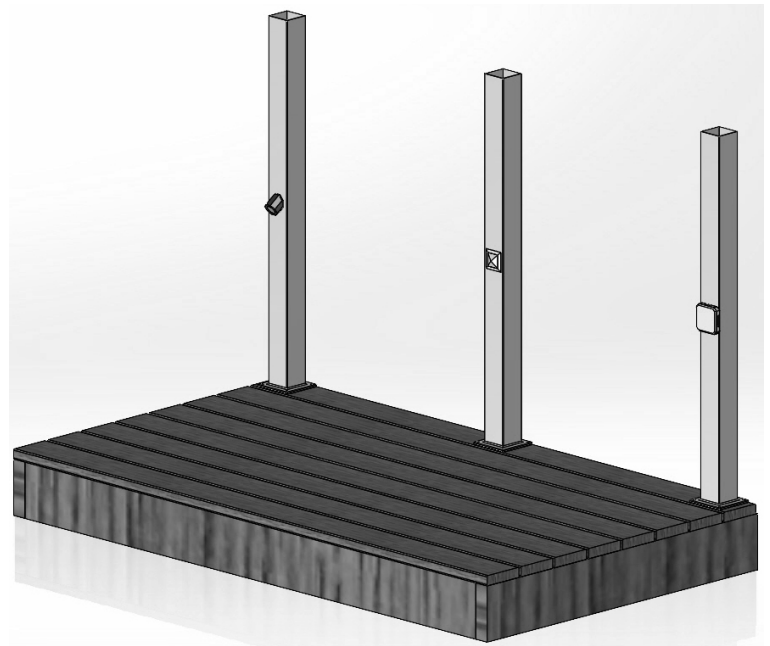

NOTE: All wiring and splitters are mounted to inside of framing, picture is just representation of where to place these in general.

NOTE: Avoid railing brackets and locations for deck rail lights when running wires up posts.

NOTE: It is recommended to install wiring and splitters before decking and railing have been installed. **DO NOT** run wires between joists and deck boards.

HELPFUL TIPS

- » Follow the appropriate building and electrical codes when installing all DEKOR® lighting products.
- » Leave wire slack to make fixture terminations.
- » It is recommended to determine placement of lighting under dark conditions prior to drilling/installation.
- » Post lights should be used at the top or the bottom of the stairs, or used in conjunction with post cap lights.
- » Carefully drill holes perpendicular to surface to avoid producing an enlarged hole. Light fixture will have a loose fit if hole is enlarged. **NOTE:** Silicone caulk will be required to anchor light in place in over-drilled recessed light holes.
- » It is best to use splitters at each post that has lights and, depending on spacing, in between each DEK-DOT™ and recessed light.
- » Unused splitter female connections need to be capped. Either use provided caps or a weather resistant silicone to prevent corrosion or water damage.
- » All splitter female connection ports are powered so any or all can be used.
- » **DO NOT** use more than one transformer on each circuit.
- » Each light has a pig-tail lead attached with an approx. 5' (1.8m) length and has a male connector that plugs into splitter.
- » To ensure all components are in working condition it is recommended to have power source attached when installing lights.

CAUTION:

When making a connection between a Plug N Play connector or a splitter; observe the polarity key to make the proper connection. The male and female connectors have a flat side that **MUST MATCH UP**. **DO NOT** force the connectors together.

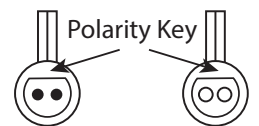

How to install DEKOR® Deck Lighting / CONTINUED

General Information

- » ALWAYS check local codes before beginning your project.
- » USE DEKOR® TRANSFORMERS ONLY. Using any other type of transformer voids the warranty.

TRANSFORMER CAPACITY BY TYPE		
Type of Light	5A Transformer EZ Max Transformer	2.5A Transformer EZ Transformer
Sapphire Post Light	38	23
Petite Post Light	45	28
Elite Post Light	45	28

The list above is for maximum number of each individual types of lights. If mixing and matching lighting reference the transformer calculator at DEKORLIGHTING.com.

How to install DEKOR® Sapphire, Petite, and Elite Post Lights

NOTE: Instructions shown below are for new deck installation and are shown BEFORE railing system has been installed.

1. Place post sleeve over wood post and mark desired height, centered on post sleeve for post light location.

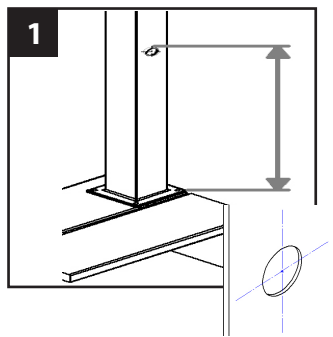

NOTE: If deck boards are not installed yet place an appropriate deck width spacer board to ensure post sleeve is at correct height.

2. After marking the desired location leave the sleeve on the wood post and drill through the sleeve with a DEKOR forstner bit (7/8") and at least a 1/4" deep into the wood post. This allows clearance for the wire when the light is seated in the post sleeve hole.

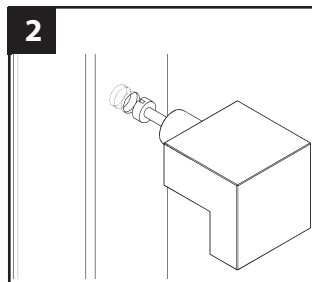

- 2A. Remove the sleeve and drill additional overlapping holes to allow room for wire and light clearance.

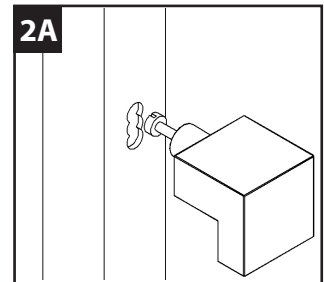

- 2B. For an aluminum post drill a 3/8" pilot hole first. Follow through with a 7/8" bit.

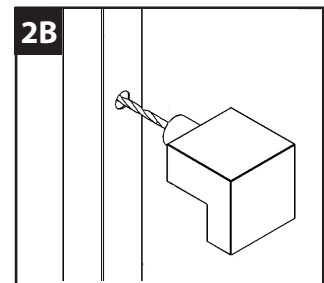

3. Measure and mark the location of the wire pass through hole in the deck board based on the wood post and sleeve. If an aluminum rail is used measure based on the hole in the bottom of the post. use a 3/8" bit to drill the hole for the wire passthrough.

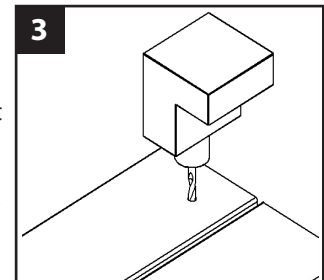

4. Feed the wire from the light through the hole in the post sleeve. Feed the bottom of the post sleeve through the post sleeve skirt. Carefully while holding the wire out of the way at the bottom slide the post sleeve and skirt assembly over the wooden post.

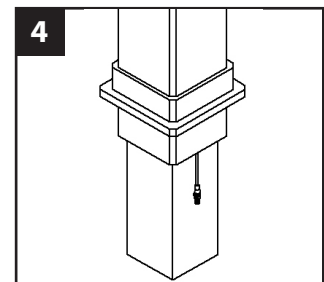

5. Feed wire through deck board. Slide the post sleeve skirt over the wire.

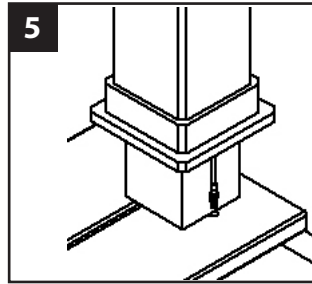

5. Add a small silicone bead around the back of the light.

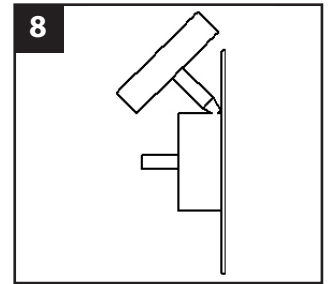

6. Feed wire through deck board. Secure aluminum post to deck board with provided anchor bolts.

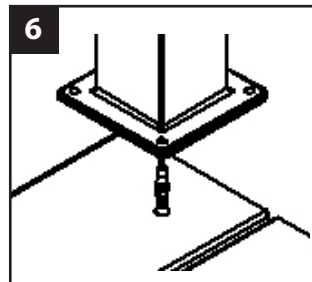

5. Seat the light into the drilled hole. Rotate the light to the desired look and let cure.

Note: It may be necessary to tape over the light and onto the post until the silicone has cured.

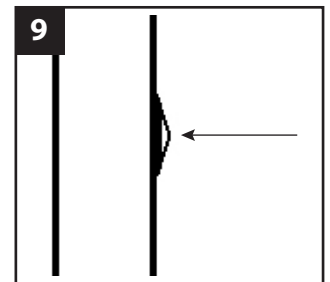

7. Add a small amount of dielectric grease into the T-splitter ports before making the connections.

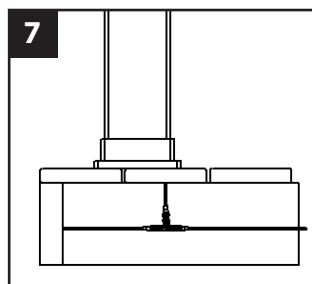

NOTE: If railing has already been installed, lead wires will need to be fished through the post sleeve to reach the desired location for the deck rail light. In some cases if the provided lead wire does not fit (due to connector size), the wire connectors can be cut off and wire nuts can be used. Test lights with the power on. If lights wired with this method do not function, switch the connector wires.