

# DEKOR® Shelly Universal Light Installation Instructions

## LIGHTING AND WIRING OVERVIEW

### PARTS

**A** Shelly Universal Light



» 20', 5', 10', 20', 40', and 60' male to male connection/extension wires sold separately.

**B** Splitter Options

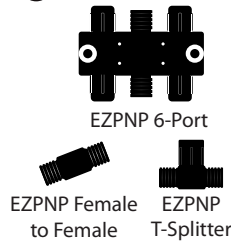

### TOOLS NEEDED

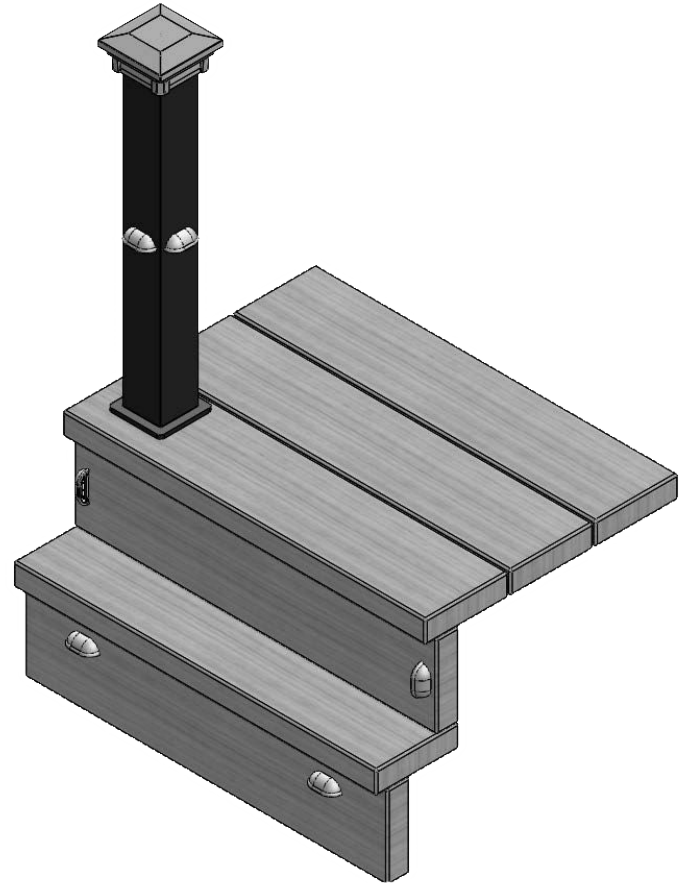

**NOTE:** All wiring and splitters are mounted to inside of framing.  
**NOTE:** Avoid railing brackets and locations for deck rail lights when running wires up posts.  
**NOTE:** It is recommended to install wiring and splitters before decking and railing have been installed.

**DO NOT** run wires between joists and deck boards.

### HELPFUL TIPS

- » Follow the appropriate building and electrical codes when installing all DEKOR® lighting products.
- » Leave wire slack to make fixture terminations.
- » It is recommended to determine placement of lighting under dark conditions prior to drilling/installation.
- » The Shelly light can be mounted with the lens facing in the desired direction. Example: Mount the light to a post with the lens facing down. Mount the light to stairs with the lens facing down, left, or right. Mount in a cabinet with the lens facing up, left, right, or down.
- » When mounting to a post that also has a post cap light it is recommended to run the wire up to the post cap light and connect with a T-splitter.
- » Unused splitter female connections need to be capped. Either use provided caps or a weather resistant silicone to prevent corrosion or water damage.
- » All splitter female connection ports are powered so any or all can be used.
- » DO NOT use more than one transformer on each circuit.
- » Each light has a 6" pigtail lead attached with a (various lengths) male to male connector cable that plugs into a splitter.
- » To ensure all components are in working condition it is recommended to have power source attached when installing lights.

## CAUTION:

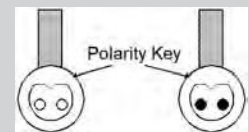

When making a connection between a Plug-N-play connector or splitter, observe the polarity key to make the proper connection. The male and female connectors have a flat side with a V-notch that **MUST MATCH UP**. Do not force the connectors together. The Plug-NPlay connectors are waterproof and they seal with an O-ring and a locking collar. **Note:** The NexGen LEDs will glow red if plugged in reverse.

# DEKOR® Shelly Universal Light Installation Instructions

## General Information

» ALWAYS check local codes before beginning your project. USE DEKOR® TRANSFORMERS for the Limited Lifetime warranty. Using any other type of transformer the lights will have a 3-year warranty.

TRANSFORMER CAPACITY BY TYPE		
Example Light	5A Transformer EZ Max Transformer	3A Transformer EZ Transformer
Shelly Universal Light	20	12

The list above is for maximum number of each individual types of lights. If mixing and matching lighting reference the transformer calculator at [DEKORLIGHTING.com](http://DEKORLIGHTING.com).

## Planning

**NOTE:** Prior to installing, plan locations of lights, power supply, timer, and dimmer. These need to be accessible for service. It is required to install a GFCI to help prevent damage to lights caused by electrical surges.

1. Dimmer remote works in a 30' (9 m) radius of the unit.
2. Install dimmer in a dry location.
3. You must install timer vertically with receptacle facing down. Timer must be at least 1' (.305 m) from ground level when installed as per federal safety code height regulations. To use the dusk/dawn feature the timer must be in view of the sun.

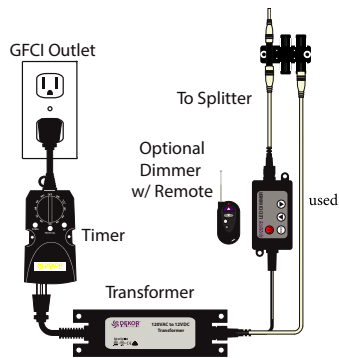

## Installing Wiring

**NOTE:** It is best to install cables and splitters before railing and decking have been installed. Connect to each required splitter using male-to-male cables (lengths vary).

## How to install DEKOR® Shelly Universal Light

1. Place post sleeve over wood post and mark desired height, centered on post sleeve for post light location.

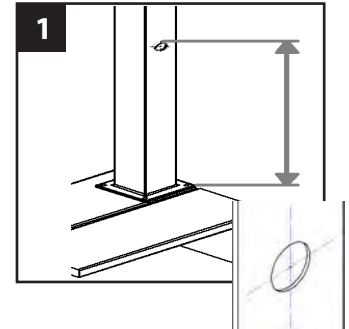

**NOTE:** If deck boards are not installed yet place an appropriate deck width spacer board to ensure post sleeve is at correct height.

**NOTE: Instructions shown below are for new deck installation and are shown BEFORE railing system has been installed.**

2. After marking the desired location leave the sleeve on the wood post and drill through the sleeve with a 3/8" bit for the wedge and angle bracket. For the dual bracket use a bit (7/8") and drill at least a 1/4" deep into the wood post. This allows clearance for the wire when the light is seated in the post sleeve hole.

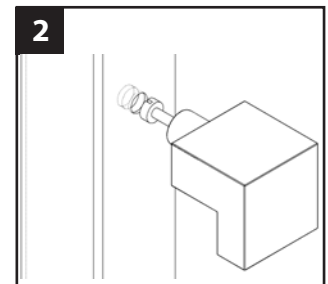

- 2A. When using an aluminum post drill a 1/2" hole for the wedge, and angle bracket. Follow through with a 7/8" step bit for the dual bracket.

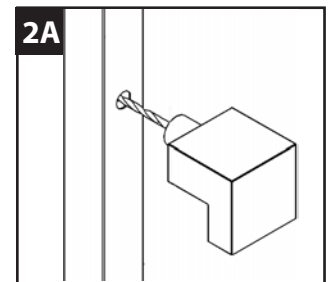

## DEKOR® Shelly Universal Light Installation Instructions

2B. Remove the sleeve and drill additional overlapping holes in the wood post to allow room for wire and light clearance.

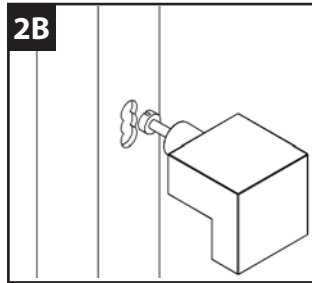

**NOTE:** If railing has already been installed, lead wires will need to be fished through the post sleeve to reach the desired location for the deck rail light. In some cases if the provided lead wire does not fit (due to connector size), the wire connectors can be cut off and wire nuts can be used. Test lights with the power on. If lights wired with this method do not function, switch the connector wires.

3. Measure and mark the location of the wire pass through hole in your deck board based on the wood post and sleeve. If an aluminum post is used measure based on the hole in the bottom of the post. Use a 1/2" drill bit to drill the hole for the wire pass through.

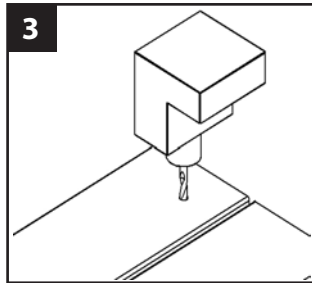

4. Feed the wire from the light through the hole in the post sleeve. Feed the bottom of the post sleeve through the post sleeve skirt. Carefully while holding the wire out of the way at the bottom slide the post sleeve and skirt assembly over the wooden post.

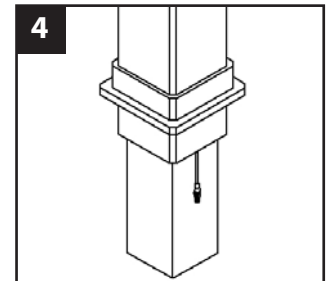

5. Feed wire through deck board. Slide the post sleeve skirt over the wire.

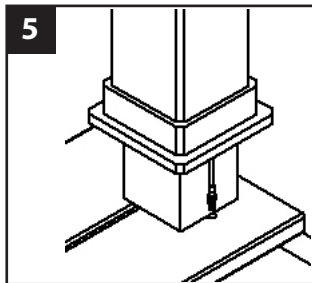

6. Feed wire through deck board. Secure aluminum post to deck board with provided anchor bolts.

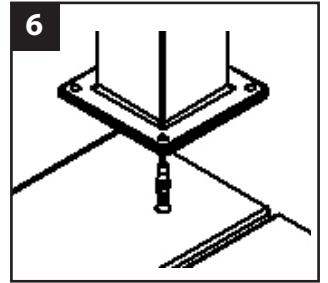

7. Add a small amount of dielectric grease into the T-splitter ports before making the connections.

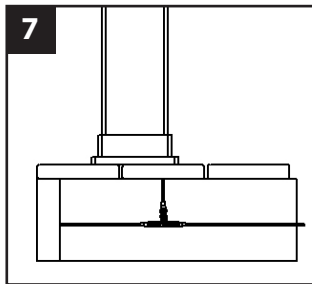

8. Place the bracket against the post with the wire hole lined up to the hole drilled in the post. Secure the bracket down with #6 wood screws or #6 self tapping screws for an aluminum post.

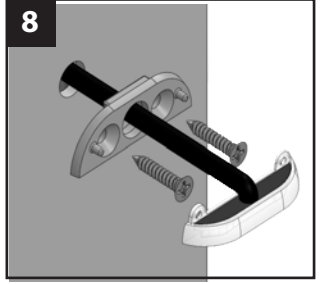

9. Seat the lens on to the pegs of the back plate. Use caution when fitting the lens tabs on the back plate pegs.

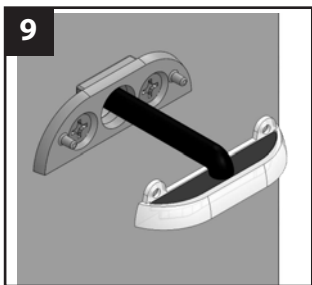

10. Slide the shell housing over the secured bracket assembly.

