

DEKOR® RECESSED LIGHTING Installation Instructions

PARTS

A Recessed Lights

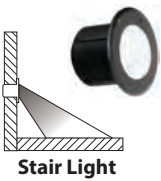

Up Light

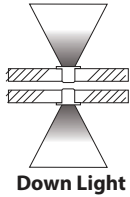

B DEK-DOT® Lights



C Splitter Options

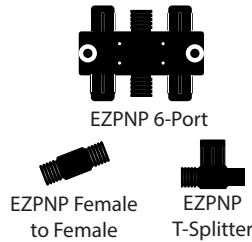

» 20", 5', 10', 20', 40', and 60' male to male connection/ extension wires and connectors sold separately.

TOOLS NEEDED



NOTE: All wiring and splitters are mounted to inside of framing, picture is just representation of where to place these in general.

NOTE: Avoid railing brackets and locations for deck rail lights when running wires up posts.

NOTE: It is recommended to install wiring and splitters before decking and railing have been installed.

DO NOT run wires between joists and deck boards.

LIGHTING AND WIRING OVERVIEW

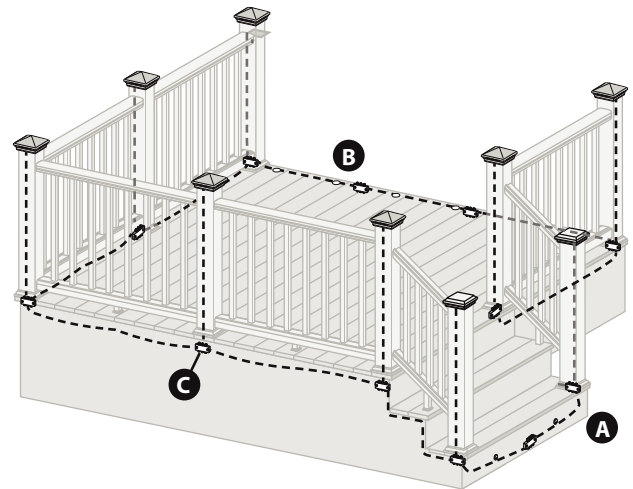

HELPFUL TIPS

- » Follow the appropriate building and electrical codes when installing all DEKOR® lighting products.
- » Leave wire slack to make fixture terminations.
- » Recessed lights work best when spaced 4' (1.22m) to 6' (1.83m) on center around perimeter of deck.
- » It is recommended to determine placement of lighting under dark conditions prior to drilling/installation.
- » Carefully drill holes perpendicular to surface to avoid an enlarged hole. **Note:** Silicone caulk be will required to anchor light in place over-drilled holes.
- » It is best to use 6-port splitters for recessed stair lights and, depending on spacing, use T-splitters in between each DEK-DOT® and recessed light.
- » Unused splitter female connections need to be capped using the provided caps or dielectric grease to prevent corrosion.
- » All splitter female connection ports are powered so any or all can be used.

- » **DO NOT** use more than one transformer on each circuit.
- » Each light has a 6" pigtail that attaches to a male cable (lengths vary). The other end of the male cable attaches to the splitters.
- » To ensure all components are in working condition it is recommended to have power source attached when installing lights.

CAUTION:

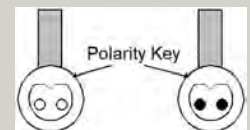

When making a connection between a Plug-N-play connector or splitter, observe the polarity key to make the proper connection. The male and female connectors have a flat side with a V-notch that **MUST MATCH UP**. Do not force the connectors together. The Plug-NPlay connectors are waterproof and they seal with an O-ring and a locking collar. **Note:** The NexGen LEDs will glow red if plugged in reverse.

DEKOR® RECESSED LIGHTING Installation Instructions

General Information

- » ALWAYS check local codes before beginning your project. USE DEKOR® TRANSFORMERS for the Limited Lifetime warranty. Using any other type of transformer the lights will have a 3-year warranty.

TRANSFORMER CAPACITY BY TYPE

Example	5A Transformer EZ Max Transformer	2.5A Transformer EZ Transformer
DEK•DOT®	45	25

The list above is for maximum number of each individual types of lights. If mixing and matching lighting reference the transformer calculator at www.dekorlighting.com.

Planning

- NOTE:** Prior to installing, plan locations of lights, power supply, timer, and dimmer. These need to be accessible for service. It is required to install a GFCI to help prevent damage to lights caused by electrical surges.

1. Dimmer remote works in a 30' (9m) radius of the unit. Install dimmer in a dry location.
2. You must install timer vertically with receptacle facing down. Timer must be at least 1' (.305 m) from ground level when installed as per federal safety code height regulations. To use the dusk/dawn feature the timer must be in view of the sun.

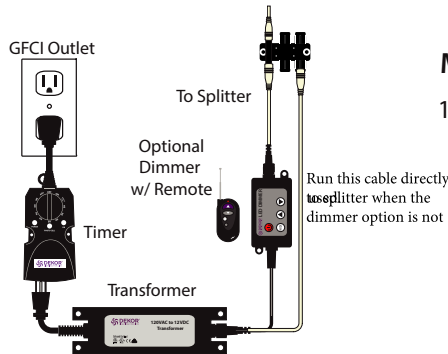

Installing Wiring

- NOTE:** It is best to install wiring and splitters before railing and decking have been installed. Connect to each required splitter using male to male cables (lengths vary).

1. You must run wiring under decking structure and behind stringers. DO NOT run wires between joists and deck boards. Use cable staples at least 1/4" (0.6 cm) wide to staple to frame. DO NOT crush wire insulation with staple.

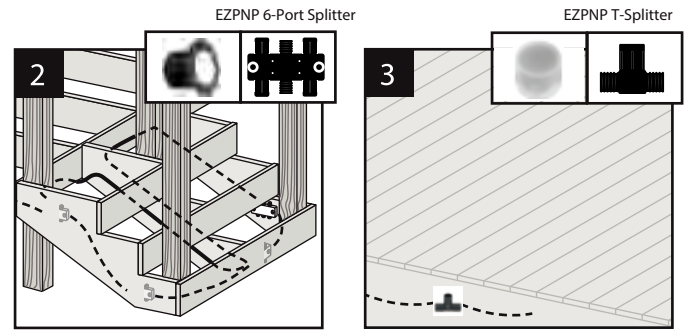
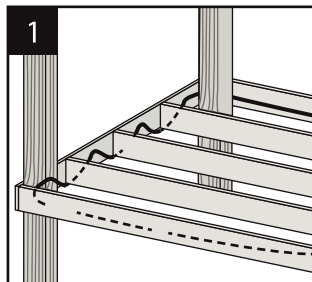

2. Wiring can be run under deck and behind stair risers. Use cable staples at least 1/4" (0.6 cm) wide to staple wire to frame. DO NOT crush wire insulation with staple. EZPNP 6-port splitters are best used when you have multiple lights in one area, such as stairs. Connect the 6" (15.2 cm) female pigtail from light into the male to male cable.
3. EZPNP T-splitters are best used when lights are spaced 6' or more feet apart from each other. Connect the 6" (15.2 cm) female pigtail from light into the male to male cable. Staple wires to frame with cable staples at least 1/4" (0.6 cm) wide. DO NOT crush wire insulation with staple.

Making Connections

1. Using hardware provided install splitters to inside of framing. Install at every where lighting is present and depending on spacing in between each riser and recessed light.

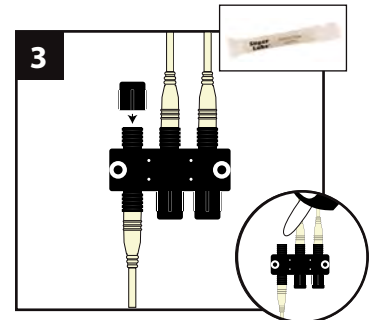
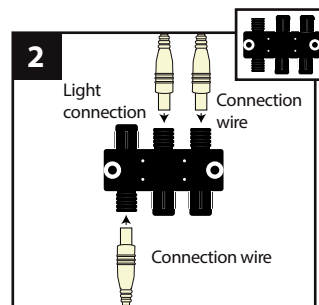
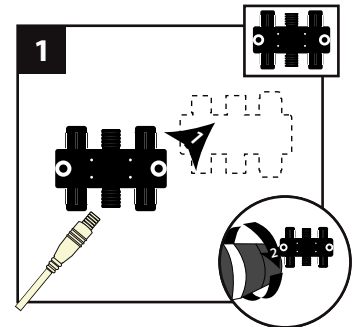

2. Attach male lead from lights to female connections on splitter. Attach male to male connection wires in between each splitter. Continue until all wiring from lights are attached to splitters and connector wires are attached in between splitters.
3. Cap off all unused female splitter connections using the provided caps or dielectric grease to prevent corrosion.

How to install DEKOR® Recessed Lighting

Installing Stair/Recessed lights

NOTE: Recessed lights should be installed after stairs and risers have been installed.

1. Mark location for light, typically 4" (10.2cm), above tread. Check local codes for lighting requirements.

NOTE: Avoid areas over stringers when possible because it will be more difficult to drill holes.

2. Drill a .9" (22.86mm) diameter hole at least 1" (25.4mm) deep into riser. If riser material is thicker than 1" (25.4mm), use a 1/2" (12.07mm) drill bit to create a hole for wires that goes all the way through riser.

3. Thread wires through hole.

4. Remember to add some silicone adhesive caulk around the case to insure proper seal and adhesion.

5. Press light housing into hole, then insert light and lens. Make connections behind stairs. Male lead cable from recessed light goes into a female connection on splitter. Also attach male to male connection cables in between each splitter. Continue until all wiring from lights are attached to splitters and connector cables are attached in between splitters. (See Making Connections section for details.)

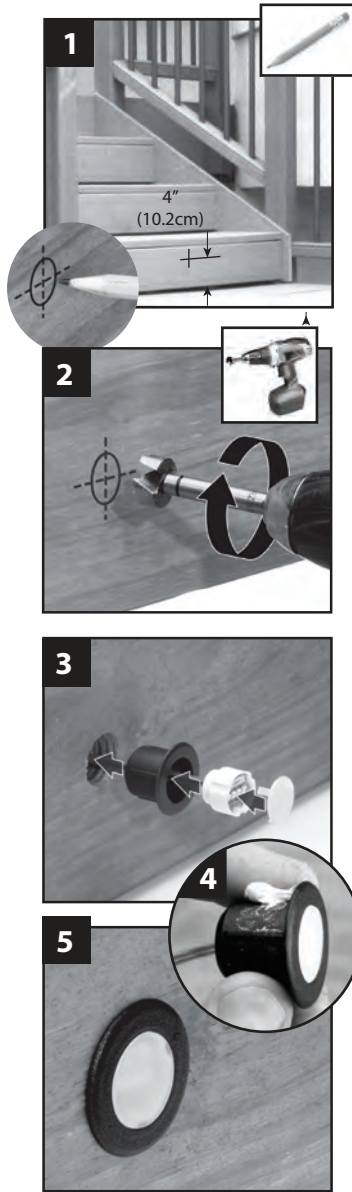

NOTE: Stair LEDs are set at 30° angle to cast light on tread. Make sure stair lights are set in case with LEDs pointed toward stair tread. Both Standard and NexGen stair lights are set to aim lights at an angle.

Standard LED



NexGen LED

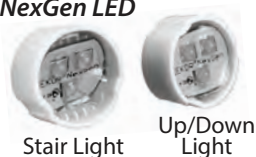

Installing Recessed DEK•DOT® lights

NOTE: Install recessed DEK•DOT® deck lights after installing decking.

1. Mark location for DEK•DOT® on deck boards.

NOTE: Avoid locations over joists when possible because it will be more difficult to drill holes through deck board.

2. Use a drill bit .9" (22.86mm) a hole 3/4" (19.05mm) deep into board. Make sure hole does not go all the way through deck board or light will fall through. Drill a 1/2" (12.7mm) hole through deck board to run the Plug-N-Play wire.

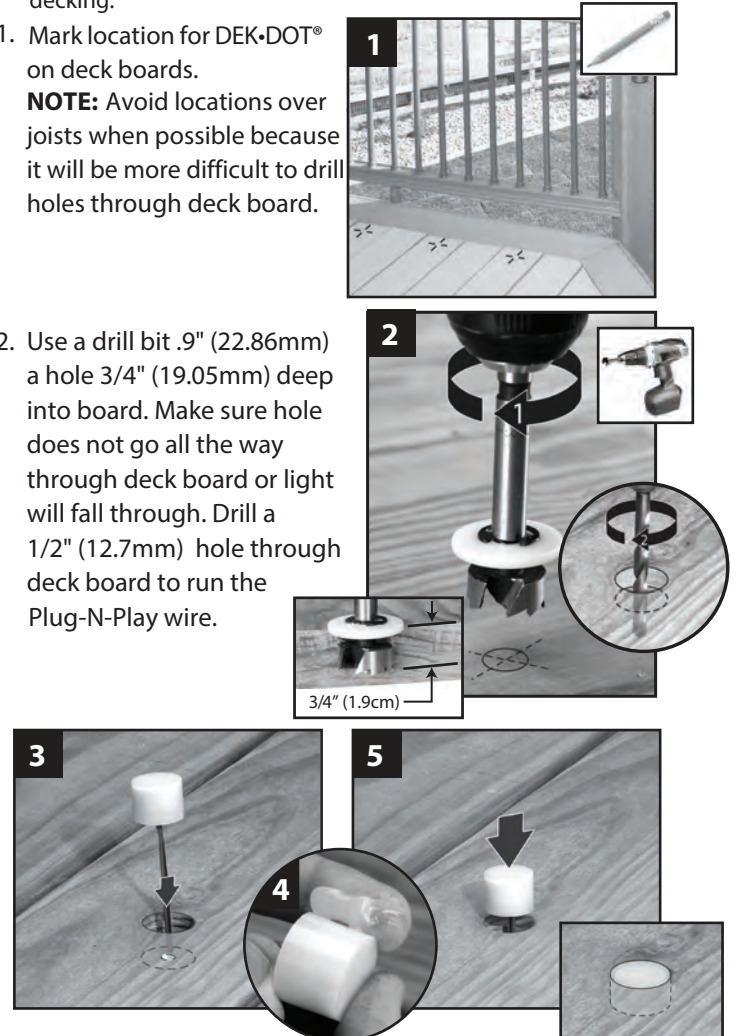

3. Thread wires through hole. DO NOT pull DEK•DOT® into hole by pulling on wires. This may damage wires or DEK•DOT®.

4. Remember to a a small amount of silicone adhesive around the dot to insure proper seal and adhesion.

5. Press DEK•DOT® into hole until flush with the surface. Make connections under deck. Male lead wire from riser light into female connection on splitter. Also attach male to male connection wires in between each splitter. Continue until all wiring from lights are attached to splitters and connector wires are attached in between splitters. (See Making Connections section for details.)