

# DEKOR® Sottile Light Installation Instructions

## PARTS

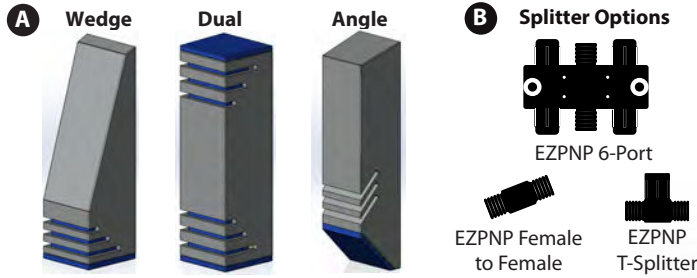

» 20", 5', 10', 20', 40', and 60' male to male connection/extension wires and connectors sold separately.

## TOOLS NEEDED

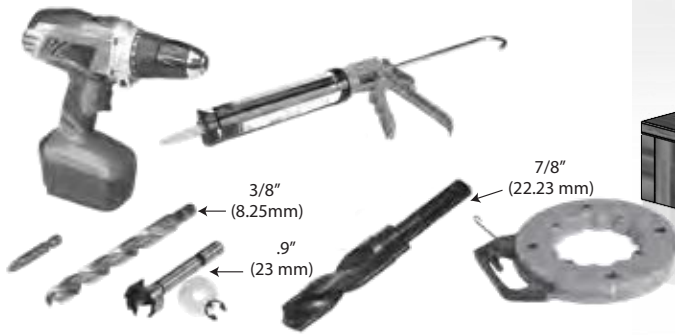

## LIGHTING AND WIRING OVERVIEW

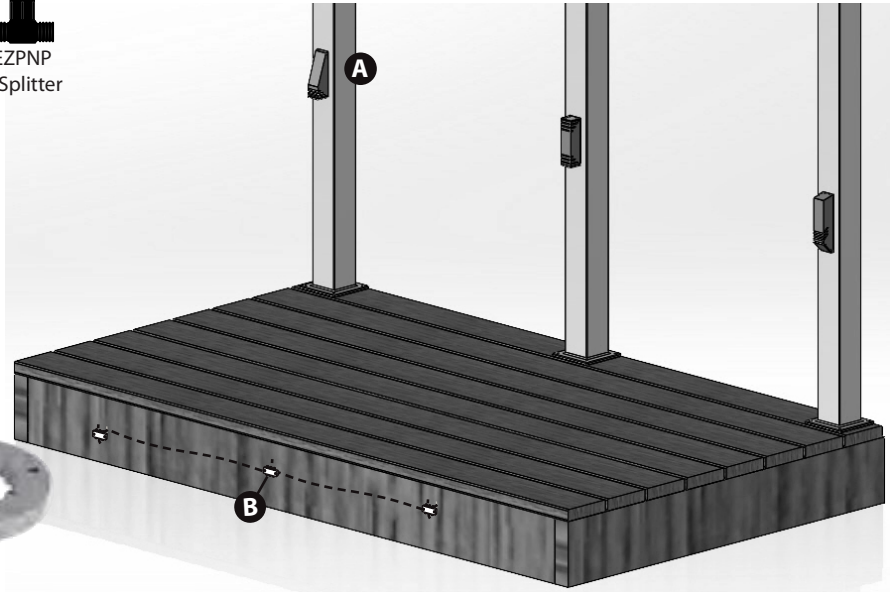

**NOTE:** All wiring and splitters are mounted to inside of framing, picture is just representation of where to place these in general.

**NOTE:** Avoid railing brackets and locations for deck rail lights when running wires up posts.

**NOTE:** It is recommended to install wiring and splitters before decking and railing have been installed. **DO NOT** run wires between joists and deck boards.

## HELPFUL TIPS

- » Follow the appropriate building and electrical codes when installing all DEKOR® lighting products.
- » Leave wire slack to make fixture terminations.
- » Rail lights should be mounted on the post between 28"-32" above the deck floor.
- » The 6-port splitters have 1 input port and 5 output ports. The T-splitters have 1 input port and 2 out put ports. The female-to-female is designed to extend cable lengths.
- » It is best to use T-splitters at each rail light under the deck frame.
- » Unused splitter female connections need to be capped. Either use provided caps or dielectric grease to prevent corrosion or water damage.
- » All splitter female connection ports are powered so any or all can be used.
- » DO NOT use more than one transformer on each circuit.

- » Each light has a pig-tail lead attached with an approx. 5' (1.8m) length and has a male connector that plugs into splitter.
- » To ensure all components are in working condition it is recommended to have power source attached when installing lights.

## CAUTION:

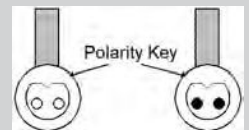

When making a connection between a Plug-N-play connector or splitter, observe the polarity key to make the proper connection. The male and female connectors have a flat side with a V-notch that **MUST MATCH UP**. Do not force the connectors together. The Plug-NPlay connectors are waterproof and they seal with an O-ring and a locking collar. **Note:** The NexGen LEDs will glow red if plugged in reverse.

# DEKOR® Sottile Light Installation Instructions

## General Information

- » ALWAYS check local codes before beginning your project. USE DEKOR® TRANSFORMERS for the Limited Lifetime warranty. Using any other type of transformer the lights will have a 3-year warranty.

TRANSFORMER CAPACITY BY TYPE		
Example	5A Transformer EZ Max Transformer	2.5A Transformer EZ Transformer
Sottile Wedge Light	20	10
Sottile Angle Light	20	10
Sottile Dual Light	20	10
The list above is for maximum number of each individual types of lights. If mixing and matching lighting reference the transformer calculator at <a href="http://www.dekorlighting.com">www.dekorlighting.com</a> .		

## How to install DEKOR® Sottile Lights

**NOTE:** Instructions shown below are for new deck installation and are shown BEFORE railing system has been installed.

1. Place post sleeve over wood post and mark desired height, centered on post sleeve for post light location.

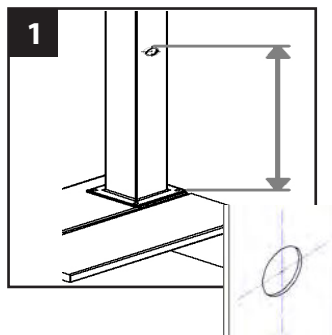

**NOTE:** If deck boards are not installed yet place an appropriate deck width spacer board to ensure post sleeve is at correct height.

2. After marking the desired location leave the sleeve on the wood post and drill through the sleeve with a 1/2" bit for the wedge and angle bracket. For the dual bracket use a drill bit (7/8") and drill at least a 1/2" deep into the wood post. This allows clearance for the wire when the light is seated in the post sleeve hole.

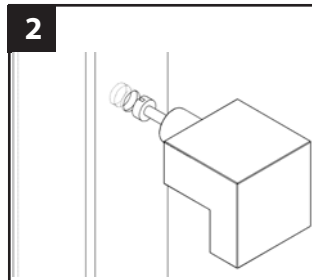

- 2A. Remove the sleeve and drill additional overlapping holes to allow room for wire and light clearance.

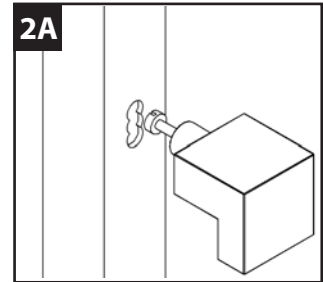

- 2B. When using an aluminum post drill a 1/2" hole for the wedge and angle bracket. Follow through with a 7/8" bit for the dual bracket.

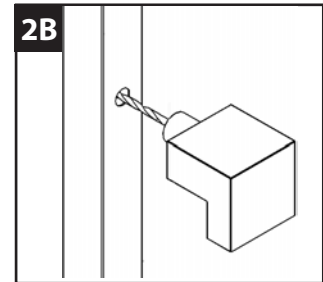

3. Measure and mark the location of the wire pass through hole in the deck board based on the wood post and sleeve. If an aluminum rail is used measure based on the hole in the bottom of the post. use a 1/2" bit to drill the hole for the wire pass through.

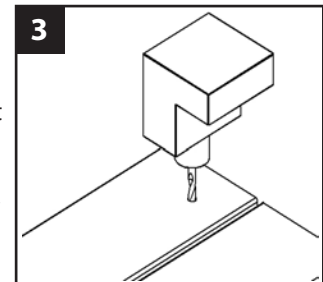

4. Feed the wire from the light through the hole in the post sleeve. Feed the bottom of the post sleeve through the post sleeve skirt. Carefully while holding the wire out of the way at the bottom slide the post sleeve and skirt assembly over the wooden post.

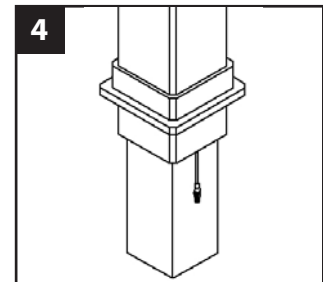

## DEKOR® Sottile Light Installation Instructions

5. Feed wire through deck board. Slide the post sleeve skirt over the wire.

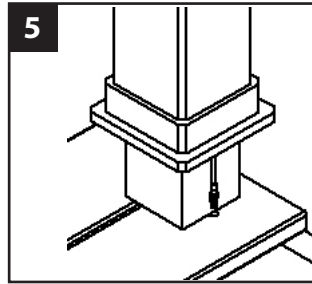

6. Feed wire through deck board. Secure aluminum post to deck board with provided anchor bolts.

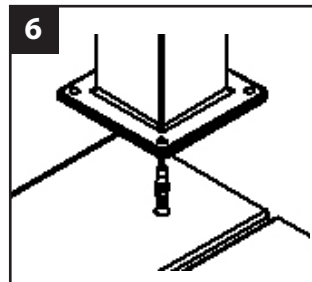

7. Add a small amount of dielectric grease into the T-splitter ports before making the connections.

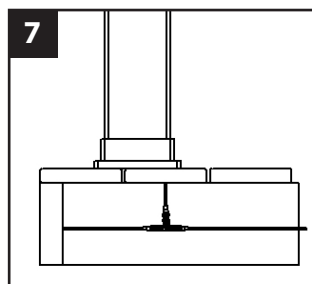

8. Place the bracket against the post with the wire hole lined up to the hole drilled in the post. Secure the bracket down with #6 wood screws or #6 self tapping screws for an aluminum post.

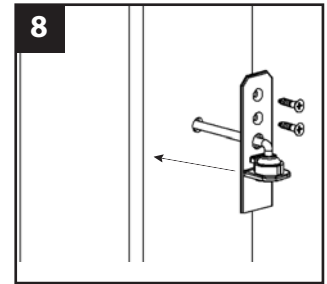

9. Slide the housing over the bracket.

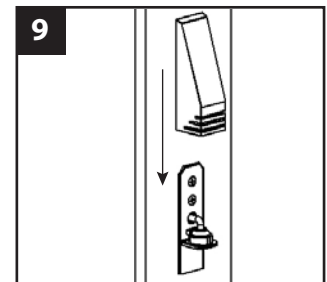

10. Insert the lens into the housing.

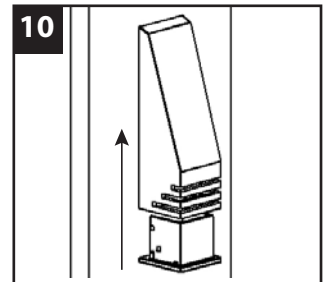

**NOTE:** If railing has already been installed, lead wires will need to be fished through the post sleeve to reach the desired location for the deck rail light. In some cases the provided lead wire does not fit (due to connector size), the wire connectors can be cut off and wire nuts can be used. Test lights with the power on. If lights wired with this method do not function, switch the connector wires.